

# OFS-standard nozzles / nozzletips

Nozzles with interior thread, clamp connection, suitable heater and thermocouple are also available

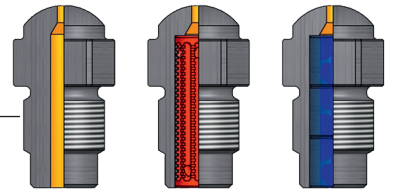

**APPLICATION FIELDS:**

The machine nozzle is an important connecting element between the plastification unit and the mold. It is very important that the measurements and the material are correctly selected to suit the processing application, plastic material, the plastification unit and the mold. Otherwise, there could be a lot of interruptions in production and faults on the plastic parts. By using the suitable material and optimum rheological design, the OFS-machine nozzle ensures the best conditions for every injection moulding

application. Besides our large stock of standart nozzles, we also deliver specially designed nozzles in a short time and at the best prices.

**YOUR BENEFIT:**

- ▶ high quality tool steel
- ▶ vacuum hardened
- ▶ contact- and sealing surfaces polished
- ▶ flow channel polished
- ▶ optional with filter- or mixinginsert

**MORE OPTIONS:**

- ▶ with mixinginsert
- ▶ with filterinsert

**NOZZLES FOR ARBURG**

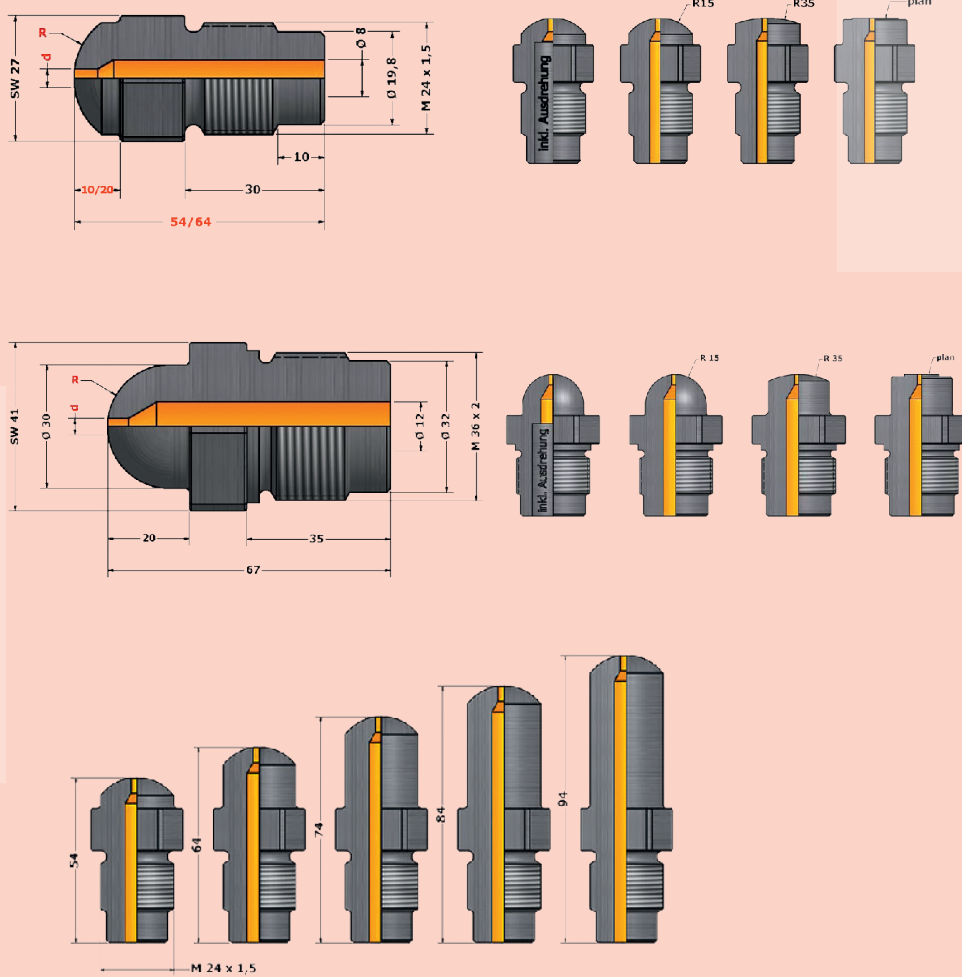

### NOZZLES FOR BATTENFELD

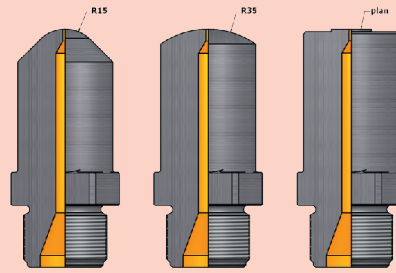
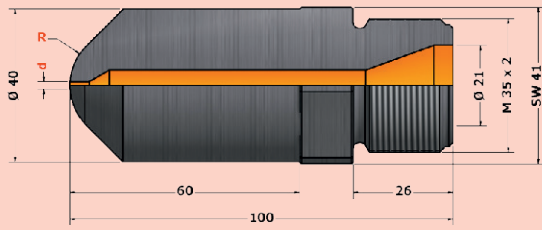

### NOZZLES FOR KRAUSS-MAFFEI

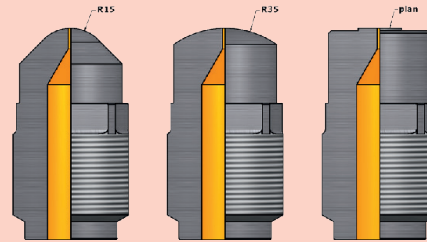
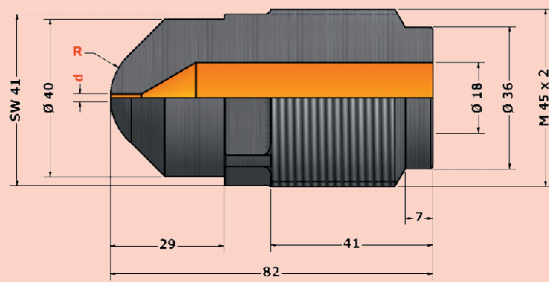
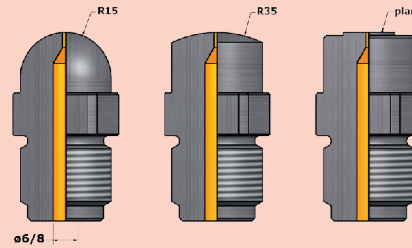
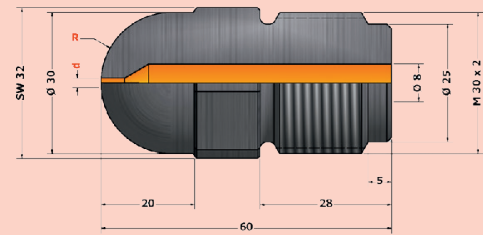

### NOZZLES FOR FERROMATIK

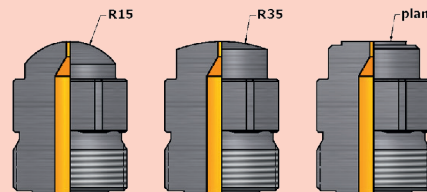
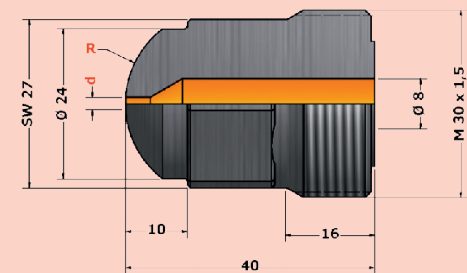

Anlagefläche in R15 / R35 / plan erhältlich

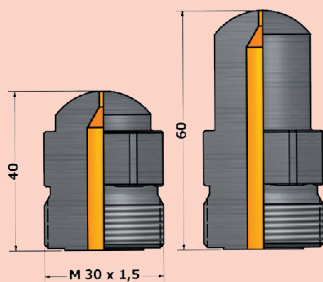

## NOZZLES FOR DEMAG

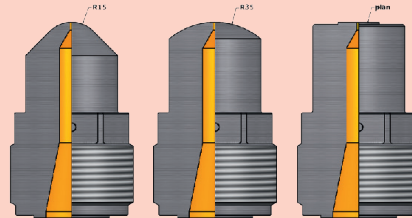
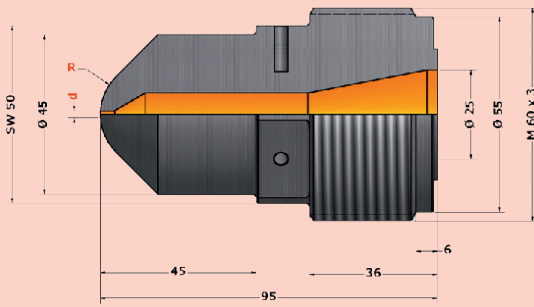
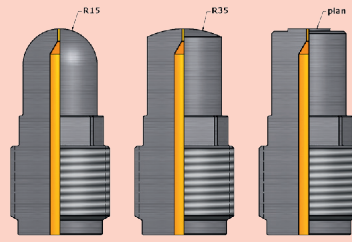
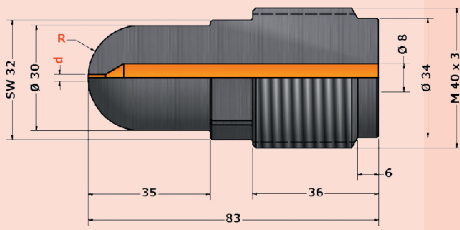

## NOZZLES FOR ENGEL

